

# FIBERGLASS PATIO DOOR SYSTEM

## Installation Instructions

**Feather River**  
DOORS  
by TRINITY GLASS

**TRINITY GLASS**  
INTERNATIONAL

Thank you and congratulations! You have just purchased a premier fiberglass patio door system. If you have an unfinished door system, we recommend that you paint/stain before installation. Refer to the Finishing Instructions section. Please read all the instructions before beginning installation. **CAUTION: Some door units are heavy and may require two people to lift and install. Use proper lifting techniques and follow safe working practices. For some larger units, we recommend consulting a professional installer.**

### TOOLS AND MATERIALS NEEDED:

- Tape Measure
- Hammer
- Carpenter Square
- Level
- Plumb bob
- Wooden shims
- #10 x 3" wood screws (galvanized or coated)
- 10d finish nails
- 9/16" drill bit
- #3 Phillips Screwdriver
- Power drill with Phillips drill bit
- 7/64" drill bit
- Safety Glasses
- Rubber gloves
- Caulking Gun
- Quality Clear Exterior Sealant
- Putty

### BEFORE YOU BEGIN:

1. Do not remove the plastic door plug until instructed to do so. It keeps the door closed and aligned during shipping. The door plug is in the hole for the door lock set. If the door unit has handles on the latch and hinge jambs, remove them.

2. Make sure that the new door will properly fit in your frame opening. The recommended frame opening is 3/4" wider and 1/2" higher than the door unit. Resize the opening if needed. It is important that the floor is level without any bumps. Use the two foot long level to make sure floor is within 1/16" of perfectly flat. Use a carpenter's square and six foot long level to check the frame opening for square and plumb. Minor (less than 1/4") out of plumb and square conditions at the sides and top can be corrected by using shims. Larger misalignments must be corrected before installation. Diagonal measurements must be equal to within 1/4" (as shown in **Figure B**).

### IMPORTANT GENERAL INFORMATION

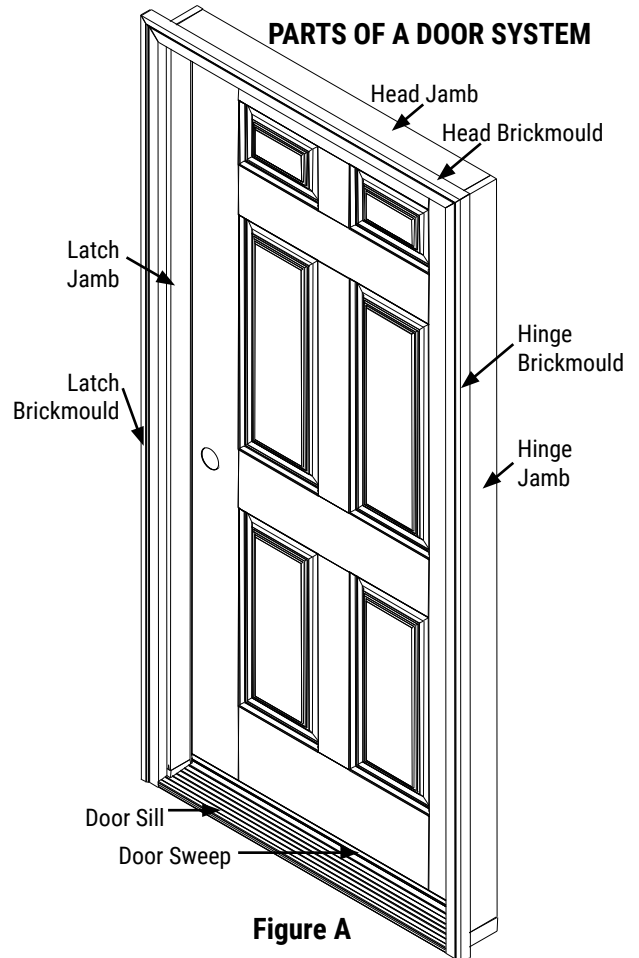
Buildings constructed prior to 1978 could contain lead paint which could be disturbed during window or door replacement. For more information on proper management of lead paint, go to: [www.epa.gov/lead](http://www.epa.gov/lead).

Contact local authorities or waste management company for proper recycling and disposal instructions for removed window or door.

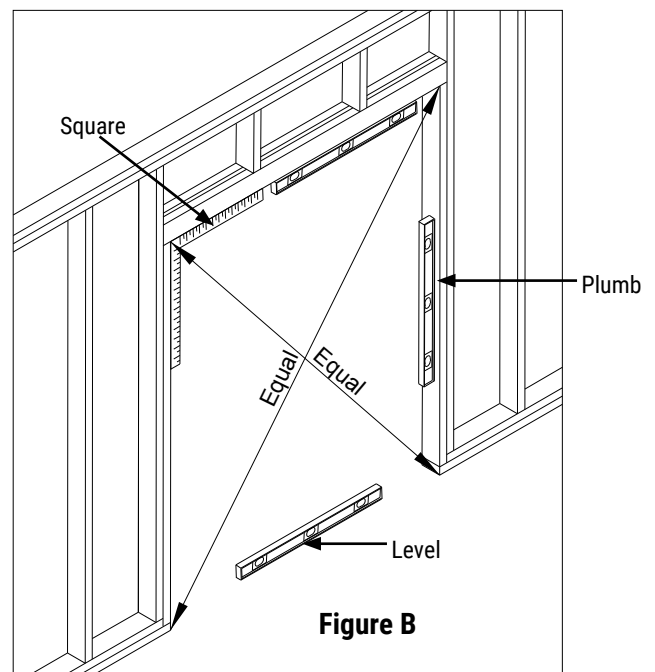
### WEATHER BARRIER INSTALLATION

An installation that is resistant to air and water leaks depends upon properly flashing the frame opening and installing a sill pan before installing the door unit. Building codes vary as to actual requirements. Also, different siding types require different flashing details. Please check with local building professionals for best flashing practices and regional code requirements.

Visite nuestra página web para esta información en español.  
[featherriverdoors.com](http://featherriverdoors.com)



**Figure A**



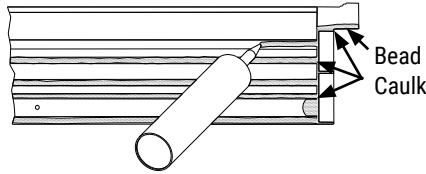
**Figure B**

## STORM DOORS

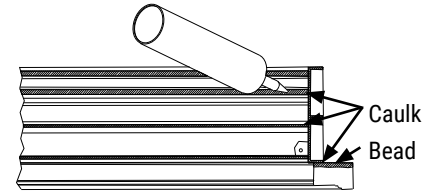
Non-Vented Storm Doors will void the Feather River Door warranty. A Non-Vented Storm Door will build up enough heat to permanently warp the door. Our doors are energy efficient and storm door protection is not necessary. If installing a storm door, it must be ventilated to reduce the amount of heat buildup. Installing a Non-Vented storm door in an area with sun exposure will cause issues due to extreme heat (UV deterioration, color fading, warping, caulk/sealant oozing).

## INSTALLATION:

**1 IMPORTANT:** Before setting the door unit to the opening, apply generous beads of caulk to the underside of the door sill at locations shown in **Figures 1a or 1b** including the jambs and brickmolds. Make sure that at least 3 lines of bead seal the full width of the sill for a complete seal.

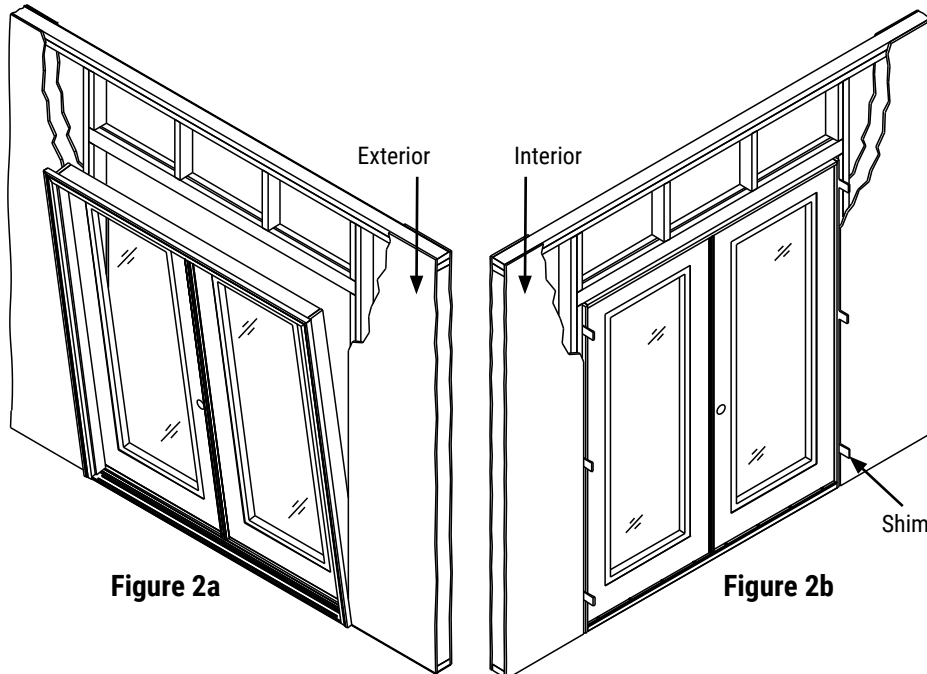


**Figure 1a**  
(inswing)



**Figure 1b**  
(outswing)

**2** From the outside, set the door unit into the opening per **Figure 2a**. For a heavier door system, get help from an assistant when lifting, setting and aligning.



**Figure 2a**

**Figure 2b**

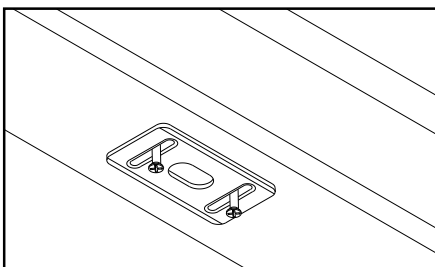
From the inside, place a solid shim (with maximum of  $\frac{1}{2}$ " thickness) between the door unit and opening frame per **Figure 2b**. For a unit that is hinged to the opening, shim directly behind each hinge between the hinge jamb and opening frame.

Check to make sure that the door unit is level, square and plumb. Temporarily secure the door unit to the frame with 10d finish nails. Fasten at about 6" below the top of the jambs and 6" above the bottom of jambs.

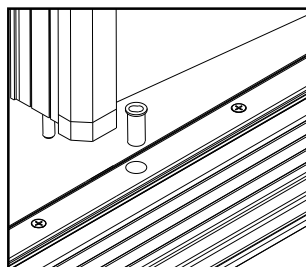
Check the weatherstrip to see if the contact and margin are equal all around. Make further adjustments for level, square and plumb. Additional shims may be used to keep the door aligned. Remove the plastic plug.

### INSTALLING ASTRAGAL RETAINING PLATE & GROMMET FOR DOUBLE DOOR UNITS:

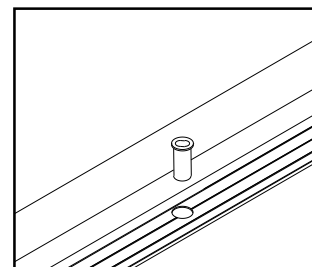
After the double door is properly aligned, use the astragal bolts to mark and drill  $\frac{3}{8}$ " diameter x 1- $\frac{3}{8}$ " min. deep hole through the head jamb and  $\frac{5}{8}$ " diameter x 1- $\frac{3}{8}$ " min. deep hole through the sill, per **Figures 2c, 2d, and 2e**. Pre-drill (2)  $\frac{1}{16}$ " pilot holes for the mounting screws for the head jamb. Install the retaining plate in the head jamb using the included hardware and insert the grommet into the  $\frac{5}{8}$ " diameter hole in the sill.



**Figure 2c**



**Figure 2d**



**Figure 2e**  
(outswing sill)

### POSITION STRIKE/DEADBOLT PLATES FOR DOUBLE DOOR UNITS:

Close both doors. Mark desired positions for strike and deadbolt plates. Loosen the retainer screws (do not completely remove screws). Place the strike and deadbolt plates into position (left image of **Figure 2f**) and tighten the screws. Only use the screws that came in the retainers. Do not use other screws as this may cause a malfunction in the operation of the doors. Check positions and adjust as needed.

### INSTALL TRIM COVERS FOR DOUBLE DOOR UNITS:

Cut the Trim Covers so that the ends fit under both the strike and deadbolt plates and butt up against the strike and deadbolt retainers (as shown in the right side of **Figure 2f** [1,2,3]). Loosen the screws on the strike and deadbolt plates and slip the Trim Cover underneath. Snap the Trim Covers into place and tighten screws.

For more detailed instructions on astragal installation and adjustment please visit: <https://www.enduraproducts.com/resources/instructions-technical-resources/>

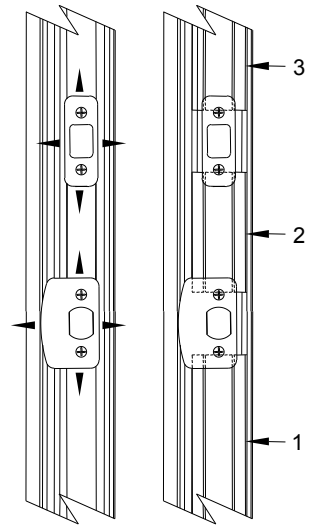


Figure 2f

**3** For doors such as single and french doors that are hinged next to the wall opening, predrill 7/64" holes and install 2 screws at the location shown in **Figure 3** on the top hinge and 1 each on the middle and bottom hinge (screws included in installation kit).

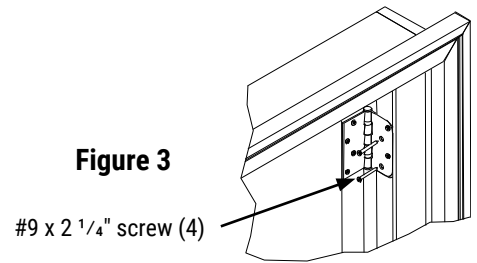


Figure 3

**4** Test for ideal contact between the door sweep and the threshold (inswing only). Put a sheet of paper above a screw on the threshold, close the door and pull. The correct adjustment has a slight tension, if the paper tears, the tension is too high. Adjust the threshold as shown in **Figure 4**. Turn screw clockwise to reduce tension or counter clockwise to increase tension. Repeat the test above each threshold screw.

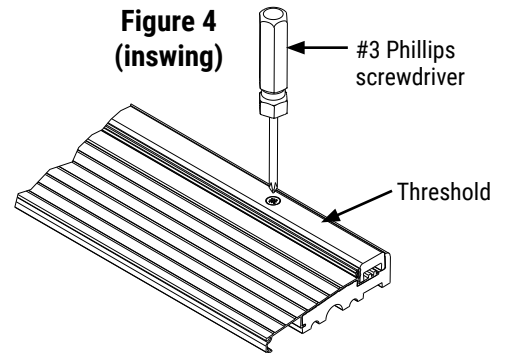


Figure 4 (inswing)

**5 IMPORTANT:** For inswing doors, install corner seal pads (included in the installation kit) at each side of an active door at the jamb, mullion or astragal bottom per **Figure 5a**. The corner seal pad should be tucked underneath the weatherstrip on each side of the active door. Caulk at the intersection of the jambs, brickmolds, mullion, sill, and floor per **Figures 5a, 5b and 5c**. Also, thoroughly caulk around between the brickmolds and exterior wall as shown in **Figure 5d**.

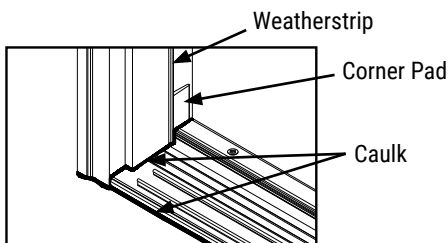


Figure 5a (inswing)

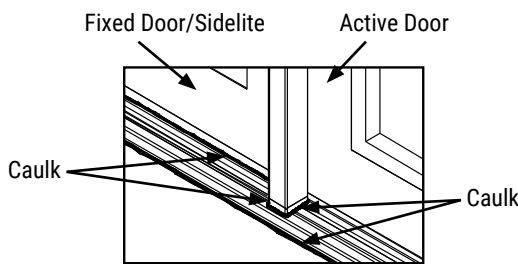


Figure 5c (mullion)

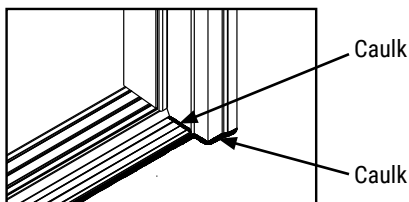


Figure 5b (outswing)

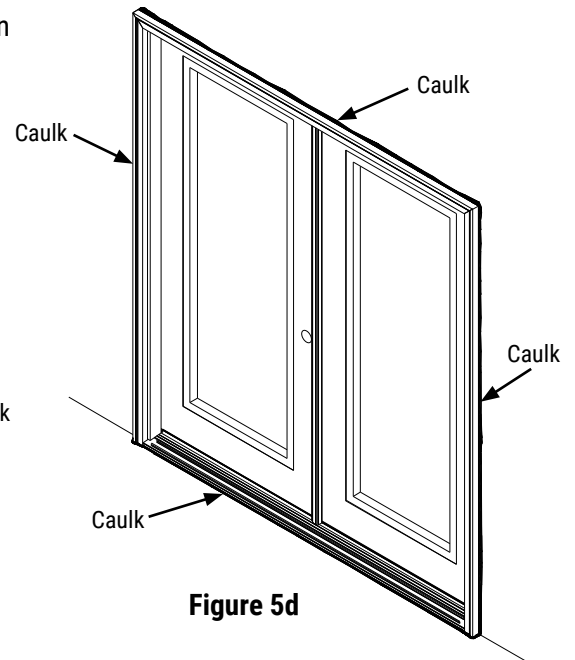
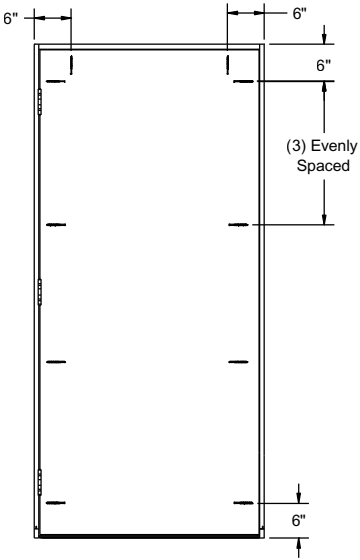
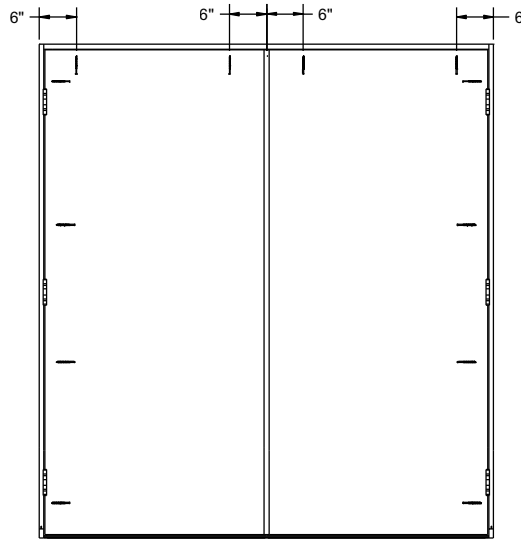


Figure 5d

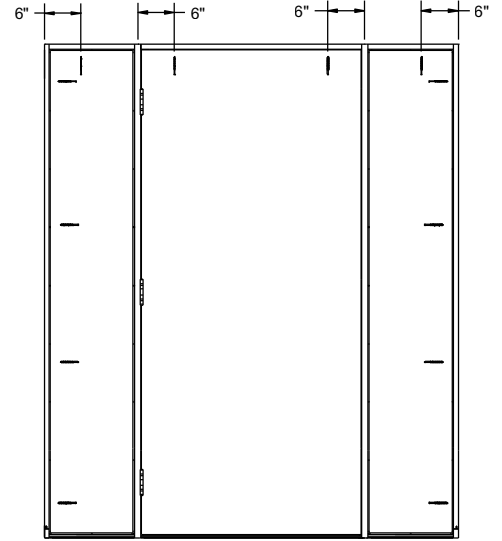
# ANCHORING DETAIL



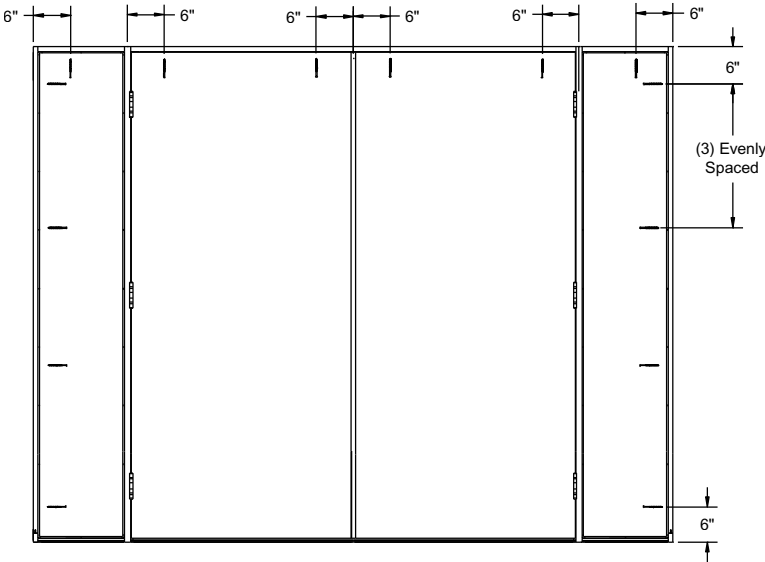
SINGLE DOOR



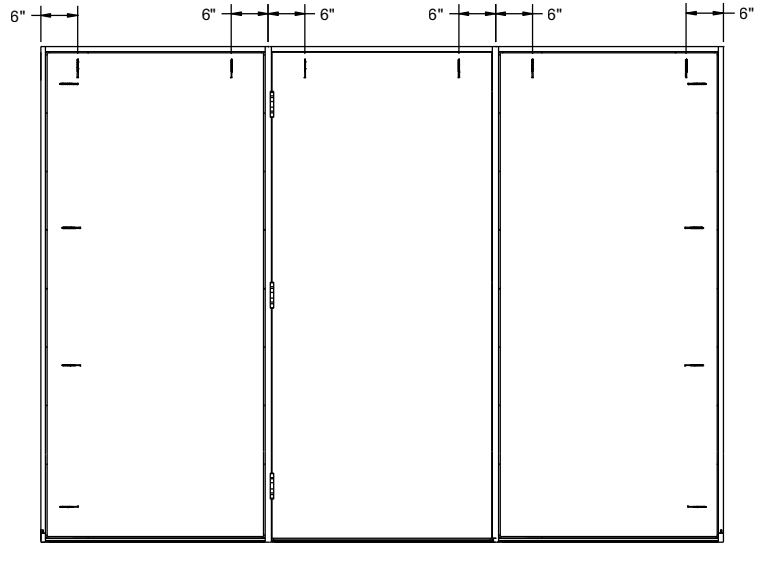
DOUBLE DOOR



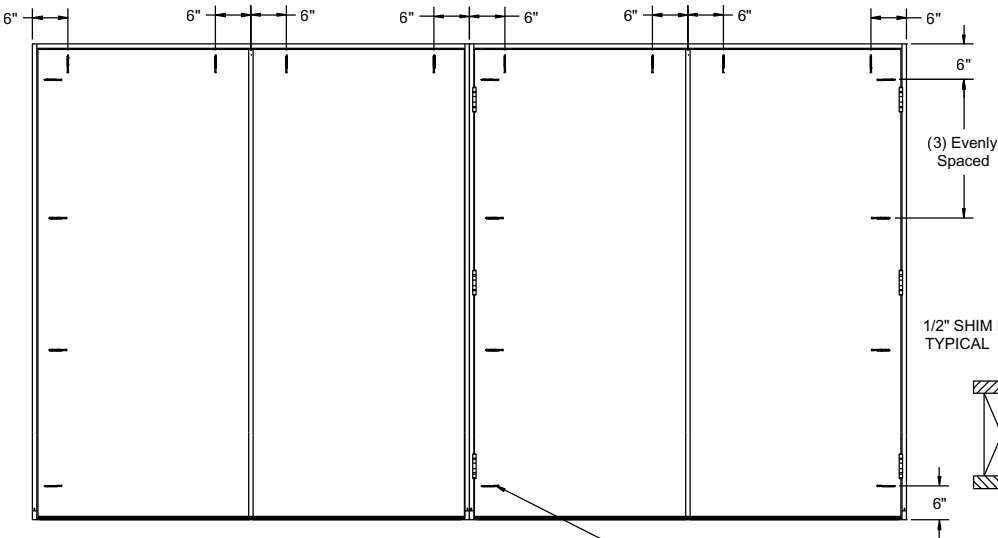
SINGLE DOOR W/ DOUBLE SIDELITES



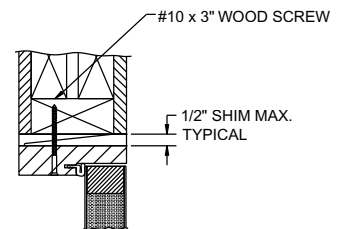
DOUBLE DOOR W/ DOUBLE SIDELITES



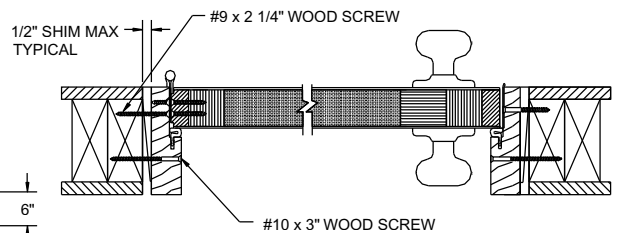
TRIPLE-UNIT DOORS



QUAD-UNIT DOORS (2 DOUBLE UNITS)  
#10 x 2" WOOD SCREW (4 PLACES)



TYPICAL HEADER JAMB ANCHORING



TYPICAL SIDE JAMB ANCHORING

## FINISHING INSTRUCTIONS:

Staining or painting an unfinished Feather River fiberglass door has never been easier. Our fiberglass door does not require special stain kits or primer. Use the same exterior stain or paint you would use for finishing your home's other trims. When finishing, remove the door from the frame and place door in a flat level surface off the floor. Do not remove sidelites from the door frame for finishing. Leave sidelites in their original installed position.

**CAUTION: PAINT OR STAIN IN A WELL VENTILATED AREA. KEEP COMBUSTIBLE PAINT, STAIN AND TOPCOAT AWAY FROM HEAT AND FLAME. KEEP OUT OF REACH OF CHILDREN.**

### STAIN FINISH:

All surfaces of a tan woodgrain door are stainable. Our patented textured fiberglass door surface yields superior stain adhesion without sanding. Select a high quality water-based stain, or a high quality gel stain. Or, select a high quality oil-based stain. Before applying a stain, wipe the fiberglass door and door lite frame with a damp cloth to remove any dirt, oil, or debris. Allow the surface to fully dry before staining. Apply an even amount of stain with a brush or lint-free cloth in the direction of the wood grain as shown in **Figure 6**. Work the stain into the surface. Lighten stain and remove excess through wiping with a clean rag before stain dries completely. For a darker appearance, apply a second coat after first coat dries. Follow the application instructions on the stain container label. After stain has dried for at least 24 hours, apply three coats of high quality exterior grade satin or low gloss polyurethane in the direction of the wood grain. Follow the label's drying time between coats.

**IMPORTANT: Use polyurethane with ultraviolet (UV) inhibitors.**

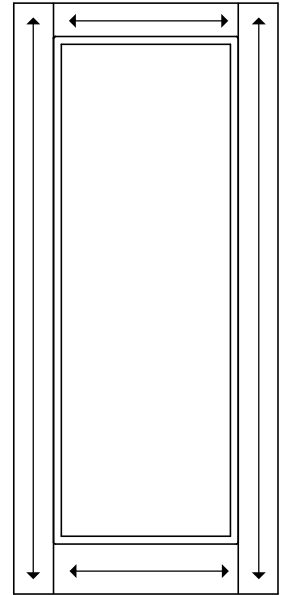
### PAINT FINISH:

Tan woodgrain or unpainted/pre-painted smooth fiberglass doors are paintable with most high quality oil or water based exterior paints. For the unpainted smooth doors, we recommend lightly sanding with 220-grit sandpaper for the best results. Before applying a paint, wipe the fiberglass door and door lite frame with a damp cloth to remove any dirt, oil, or debris. Allow the surface to fully dry before painting. Paint the door in the directions shown in **Figure 6**. Apply at least two coats of paint. Follow the brand's recommended drying time between coats.

### FINISHING WOOD AND UNFINISHED PVC COMPONENTS:

**Clear Pine Components:** We recommend staining the jambs, brickmould and other clear wood components per above stain finish instructions. Apply 2 or 3 coats of exterior grade polyurethane with ultraviolet (UV) inhibitors. Lightly sand with 220-grit sandpaper between coats for smoother finish.

**Painting Primed Wood and Unfinished PVC:** Use a quality exterior grade acrylic latex or oil-base paint. Use wood filler to putty the nail marks on the wood components before staining or painting and a PVC filler or caulk on PVC components. All unfinished doors and components must be finished within 2 weeks of installation or 6 months from the date of purchase, whichever is sooner.



**Figure 6**

## CARE AND MAINTENANCE:

In due time, harsh weathering will degrade finishes and paints. Repaint painted doors, jambs and brickmolds as soon as deterioration occurs. For factory-finished stained doors, we recommend reapplying a UV topcoat over the existing topcoat every 2-3 years, depending on the exposure conditions. We do not recommend stripping the finish. More severe exposure conditions may require more frequent maintenance. Also, replace weatherstrip, door sweep or sealant as soon as deterioration is apparent.

**CAULKING:** Just as with the finish, it is imperative that caulking/sealant is properly maintained. Any areas of deterioration should be re-caulked based on the areas pointed out in the installation instructions (Exterior Trim to Exterior Façade, Exterior Trim to Jamb, Jamb Base to Threshold/Sill). **Note:** All Feather River door lite frames come pre-caulked from the factory. The excess sealant on the door lite is normal and does not indicate a defective glazing. The excess sealant on the glass can be removed by carefully scoring the excess sealant with a razor blade and peeling it off. The excess sealant on the glass side may be better removed with the blade after scoring.

**THERMAL BOWING:** In some areas with temperature fluctuations, your door may experience signs of bowing over a period of days. This is typically due to the temperature difference between the exterior and interior part of the home. In most cases the door should return back to its normal position. This is also common during the first couple of weeks after the door is installed while the door becomes acclimated to the opening. However in areas or conditions of extreme temperature exposure on the door, some permanent bowing can be expected. In the areas of extreme temperature exposure, the effect of the temperature on the door can be reduced by following some recommendations listed below.

**DOOR EXPOSURE AND PROTECTION:** Doors protected by the elements will obviously need less maintenance and re-finishing vs. doors fully exposed to the elements. So overhangs will help provide long lasting protection to your entryway along with reduced maintenance.

**COLOR CHOICE:** As with overhangs, door colors may help reduce periodic maintenance and help with the door performance, especially in areas where doors receive an extreme amount of sun without protection. Dark colors will absorb more heat than the light colors. So if a door is absorbing a lot of heat or has constant sun exposure, it is more likely to have color fading, and even issues with warping due to differential temperature. Light colors in these situations will help reduce the amount of heat absorption and help prolong the life of the door and reduce the overall maintenance.